

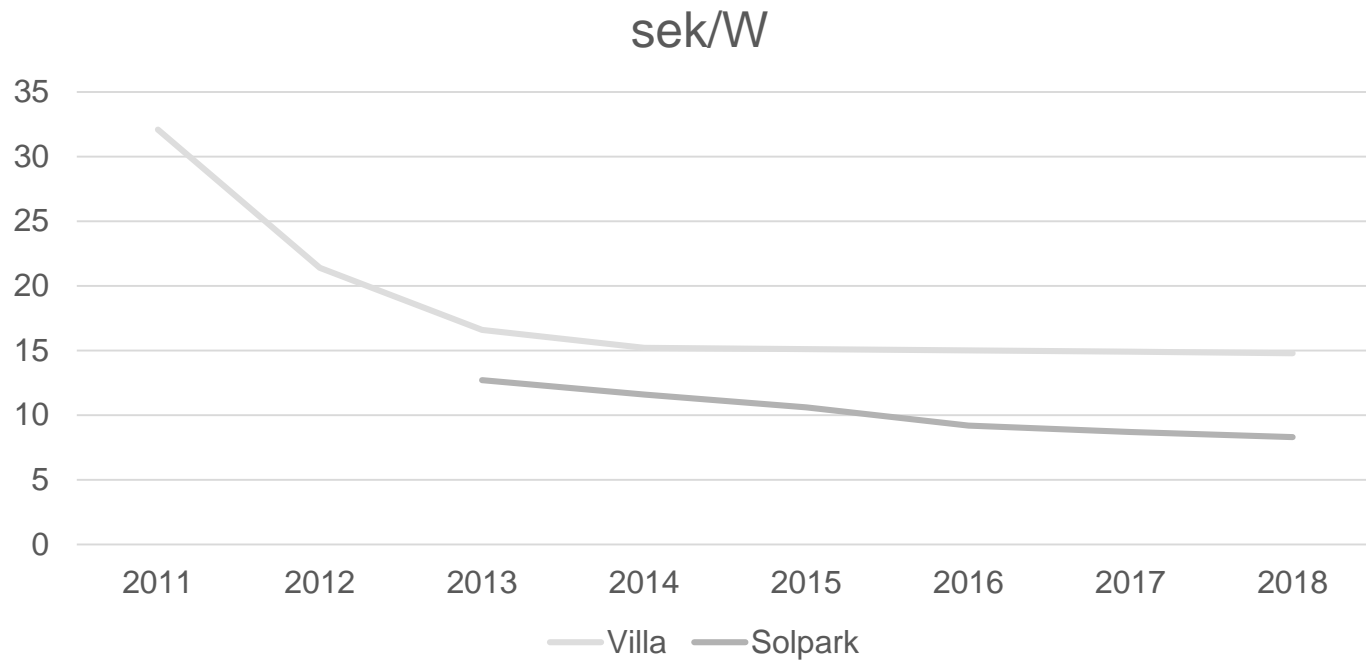

NIBE

Det ska vara enkelt att skaffa solceller!

Prisutveckling



Solceller i Sverige

2017 -Ackumulerat 325MW

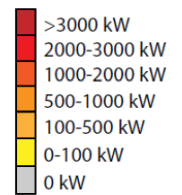
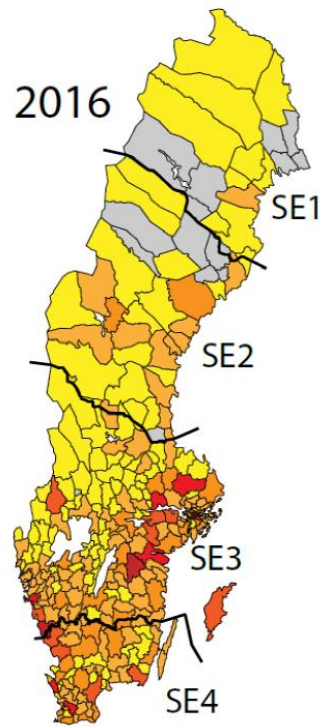
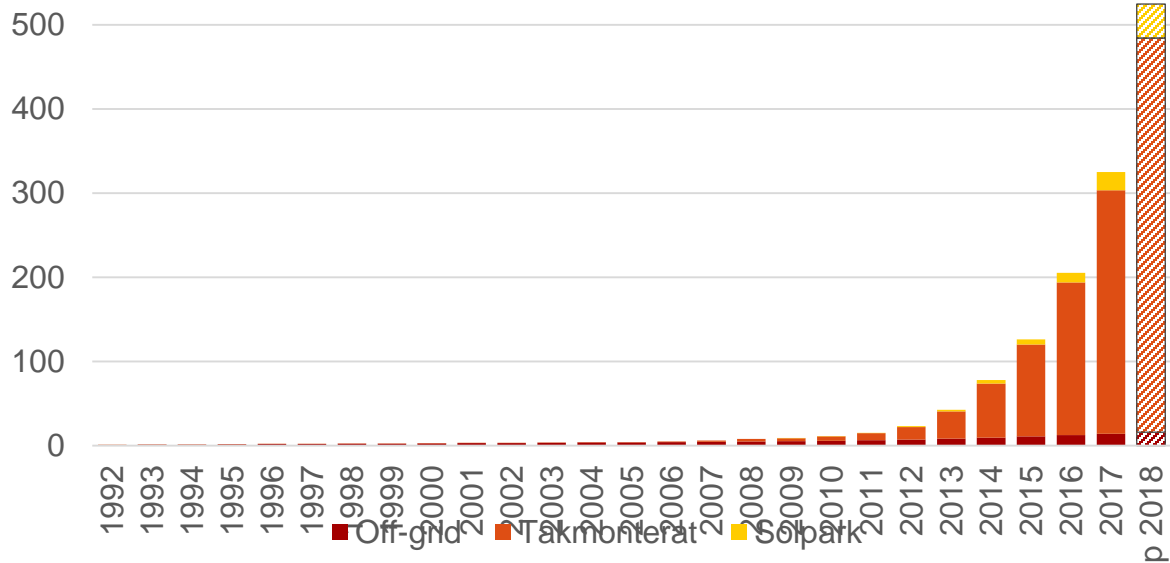

NIBE Solcellssystem inkluderar 16 st RSKnr

- System från 3kW till flera hundra kW

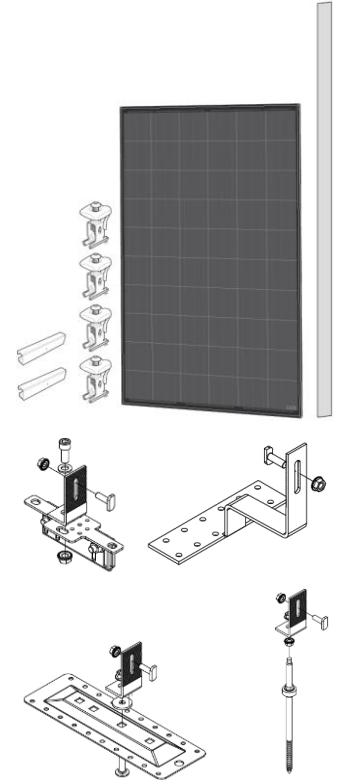
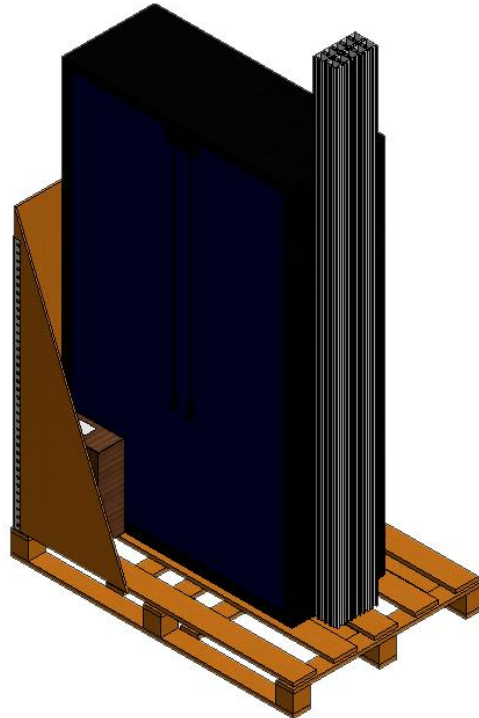

NIBE PV Solcellspaket

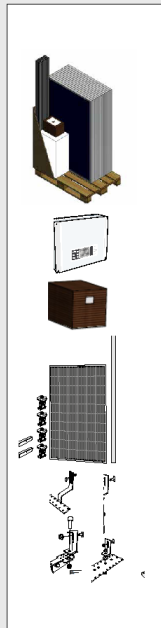

	Benämning	RSK-nummer	Bruttopris exkl. moms		3 kW	6 kW	9 kW	12 kW	15 kW	18 kW	21 kW	24 kW
	Grundsats	PVK 10-10	620 41 01	28 200 kr	1	2	3	4	5	6	7	8
	Växelriktare 1,8-4,2 kW	PVI 10-3	620 41 02	9 600 kr	1							
	Växelriktare 4,5-7,5 kW	PVI 10-6	620 41 03	17 000 kr		1						
	Växelriktare 7,8-10,5 kW	PVI 10-9	620 41 04	22 800 kr			1					
	Växelriktare 10,8-12,6 kW	PVI 10-12	620 41 05	26 800 kr				1				
	Växelriktare 12,9-18,9 kW	PVI 10-15	624 41 16	27 500 kr					1	1		
	Växelriktare 18-24 kW	PVI 10-21	620 41 06	28 000 kr							1	1
	Takfäste 20-pack tegel	PRM 11-20	620 41 07	1 200 kr	1	2	3	4	5	6	7	8
	Takfäste 20-pack plåt	PRM 21-20	620 41 08	1 200 kr								
	Takfäste 20-pack falsat	PRM 31-20	620 41 09	1 600 kr								
	Takfäste 20-pack papp	PRM 41-20	620 41 10	1 600 kr								
	Tilläggskit Panel	PVK 10-1	620 41 11	3 920 kr								
	Takfäste 1st tegel	PRM 11-1	620 41 12	90 kr								
	Takfäste 1st plåt	PRM 21-1	620 41 13	90 kr								
	Takfäste 1st falsat	PRM 31-1	620 41 14	120 kr								
	Takfäste 1st papp	PRM 41-1	620 41 15	120 kr								
	Montagesats för infästning av valfritt takfäste 20-pack	PRM 51-20	620 41 17	450 kr								
	Montagesats för infästning av valfritt takfäste 1 st.	PRM 51-1	620 41 18	30 kr								
				Paketpris ex moms	39 000 kr	75 800 kr	111 000 kr	144 400 kr	174 500 kr	203 900 kr	233 800 kr	263 200 kr
				Pris/kW ex. moms	13 000 kr	12 633 kr	12 333 kr	12 033 kr	11 633 kr	11 328 kr	11 133 kr	10 966 kr

Standardiserad Flexibilitet

Det antalet paneler som blir snyggast är oftast det rätta antalet!

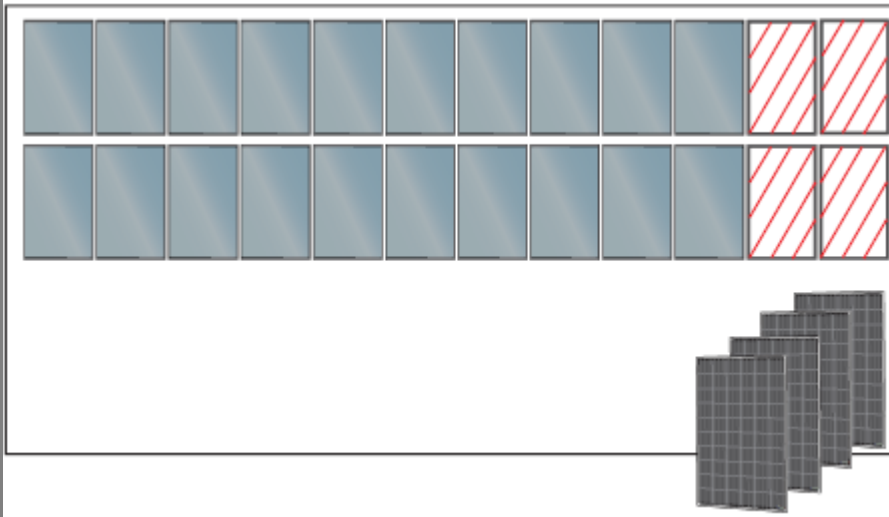

<i>Växelriktare för:</i>	<i>Min totalt</i>	<i>Max totalt</i>
1,8 – 4,2 kW	6	14
4,5 – 7,5 kW	15	25
7,8 – 10,5 kW	26	35
10,8 – 12,6 kW	36	42
12,9 – 18,9 kW	43	63
18 – 24 kW	60	80

Princip för solceller

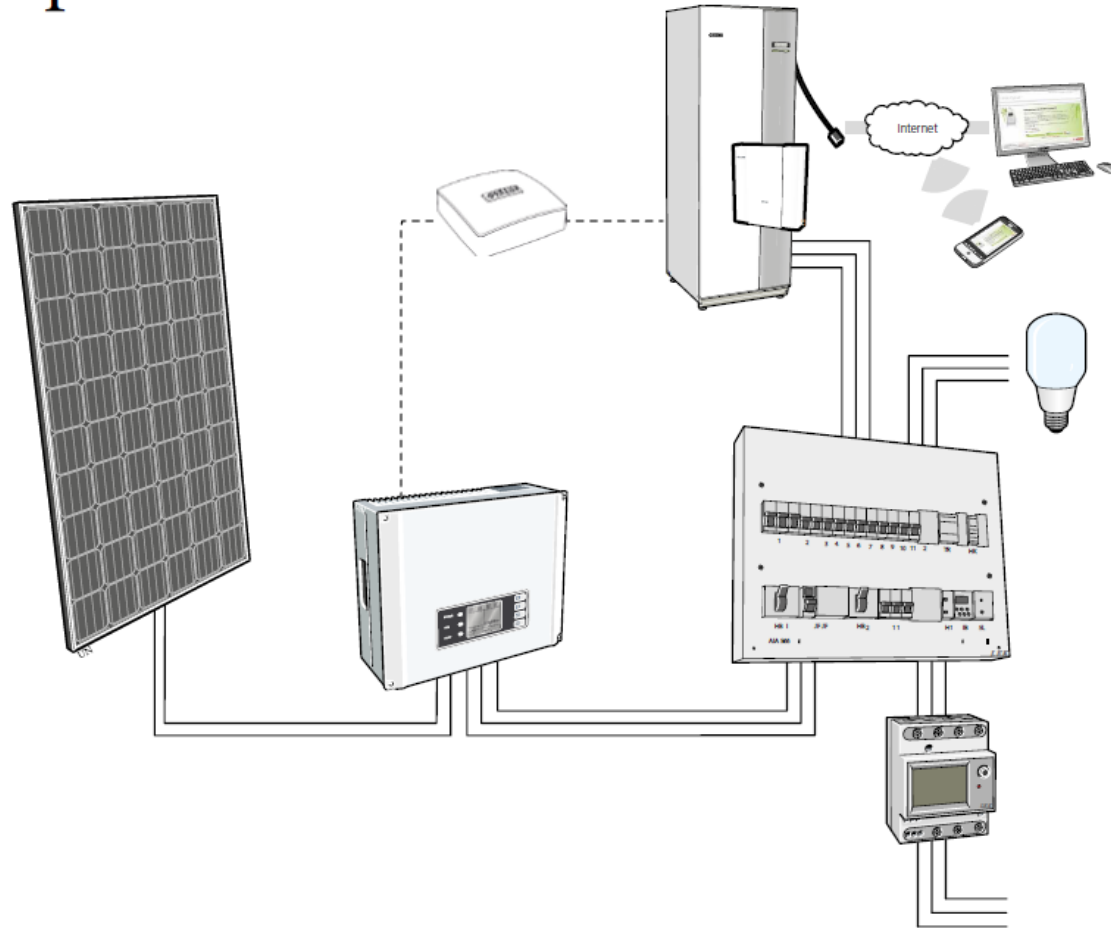

NIBE Uplink

- Aktuell soleffekt
- Ackumulerad solenergi
- Larm

Möjligheterna är nu ändlösa

- Ökad egenanvändning
- IFTTT
- Smarta hemlösningar/API
- Batterilagring
- Väderstyrning



Det ska vara enkelt att äga solceller!



ENERGY FOR LIFE

 **NIBE**

 **NIBE**